

MILLILOFT
1:100

Verkfræðistofa Ívars Haukssonar ehf.
 Suðurlandsbraut 46, 108 Reykjavík.
 Sími: 695-4337
 e-mail: ivar@vha.is
 www.vha.is
 Kennitala: 540212-2790

Hannað Í.H.	Teknað Í.H.	Samþykkt Kennitala 110383-5339
STÁLHELLA 14		
HAFNARFIRÐI		
BURÐARVIRKI		
MILLILOFT		
Mkv. 1/100	Tekn. nr. 2-1.2	Verk nr. 1255
Áritun samræmingarhönnuðar / hönnunarskjótra:		Útgáfa Dags A JUN '23

snið "1", "2", "3", "9"
1:100

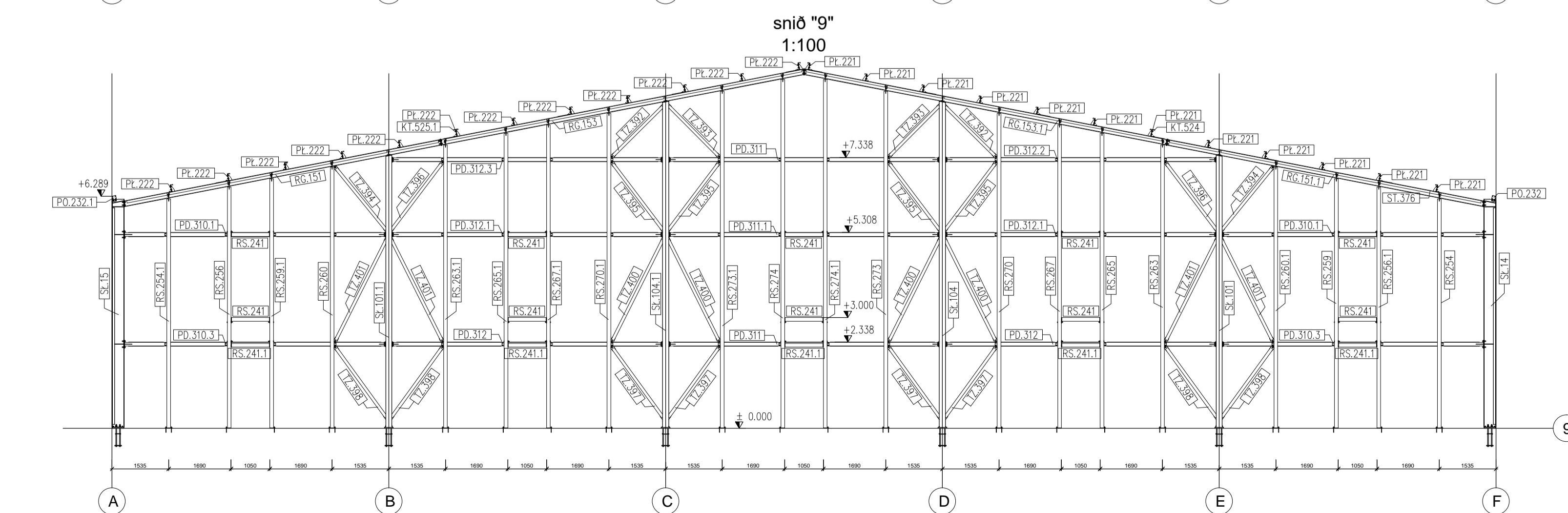
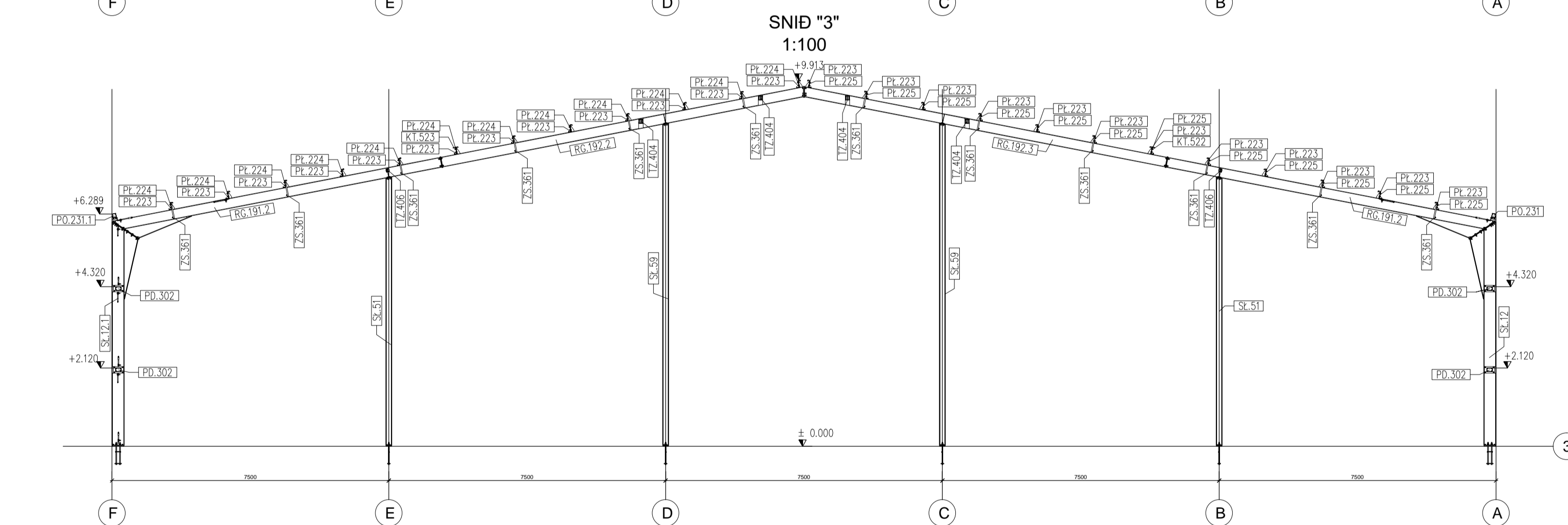
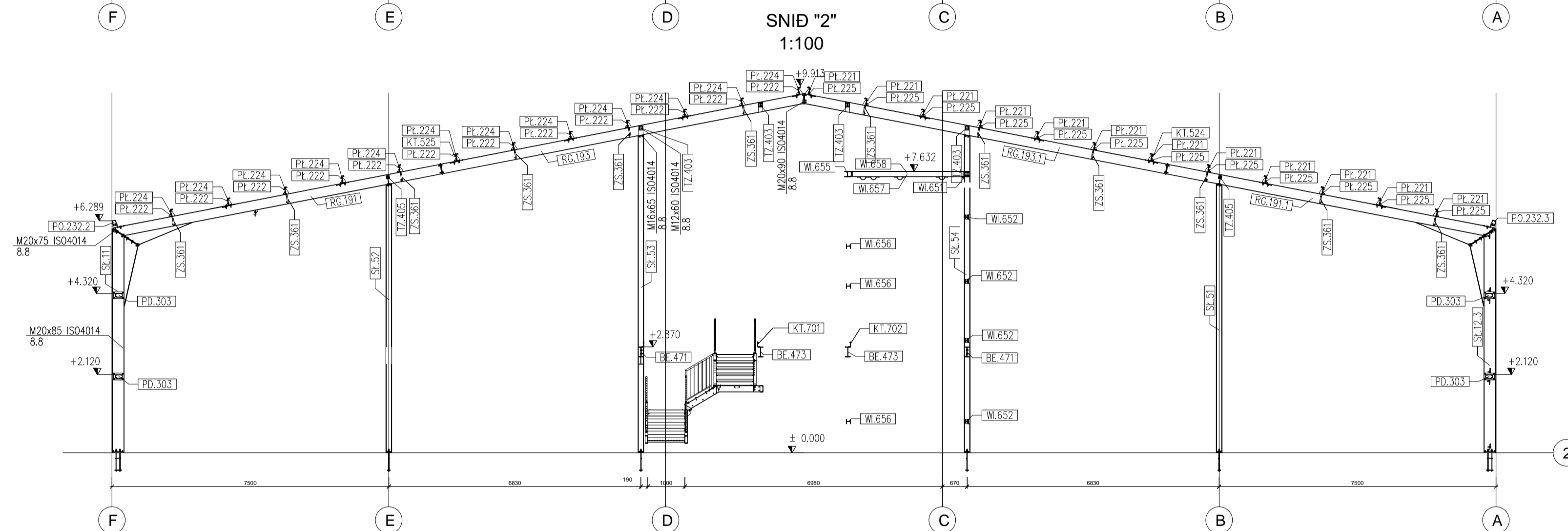
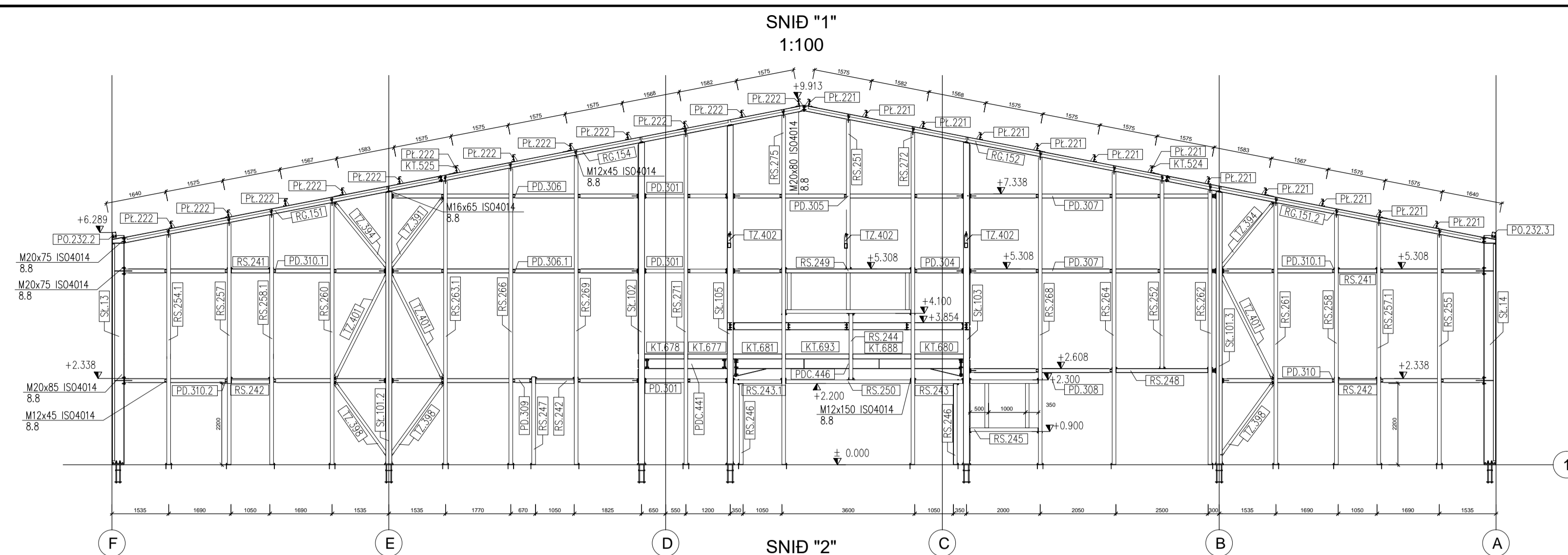

Verkfræðistofa Ívars Haukssonar ehf.
Suðurlandsbraut 46, 108 Reykjavík.
Sími: 695-4337
e-mail: ivar@vha.is
www.vha.is
Kennitala: 540212-2790

Hannað Í.H.	Teknað Í.H.	Samþykkt Kennitala 110383-5339
STÁLHELLA 14		
HAFNARFIRÐI		
BURÐARVIRKI		
STÁLGRIND SNIÐ		
Mkv. 1/100	Tekn. nr. 2-1.3	Verk nr. 1255
Áritun samræmingarhönnuðar / hönnunarskjótra:		Útgáfa A Dags. JUN '23

snið "A", "F"
 1:100

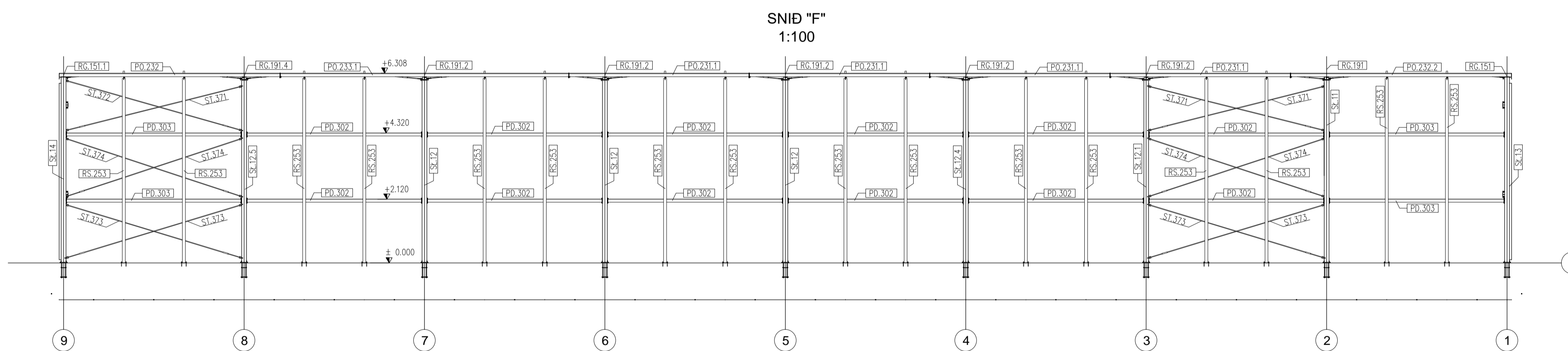
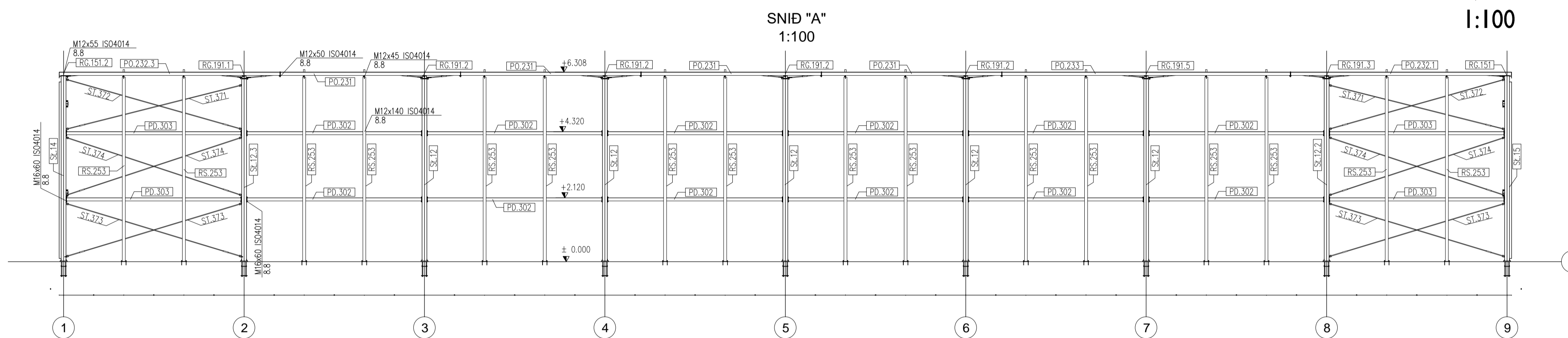

Verkfræðistofa Ívars Haukssonar ehf.
 Suðurlandsbraut 46, 108 Reykjavík.
VÍH
 Sími: 695-4337
 e-mail: ivar@vha.is
 www.vha.is
 Kennitala: 540212-2790

Hannað Í.H.	Teiknað Í.H.	Samþykkt Kennitala 110383-5339
----------------	-----------------	-----------------------------------

STÁLHELLA 14
 HAFNARFIRÐI
 BURÐARVIRKI
 STÁLGRIND SNIÐ

Mkv. 1/100	Teikn. nr. 2-1.4	Verk nr. 1255
---------------	----------------------------	------------------

Áritun samræmingarhönnuðar / hönnunarskjótra: Útgáfa Dags
 A JUN '23

SNÍÐ A-A
1:10

SNÍÐ B-B
1:100

SNÍÐ C-C
1:100

ÞAKPLAN
1:100

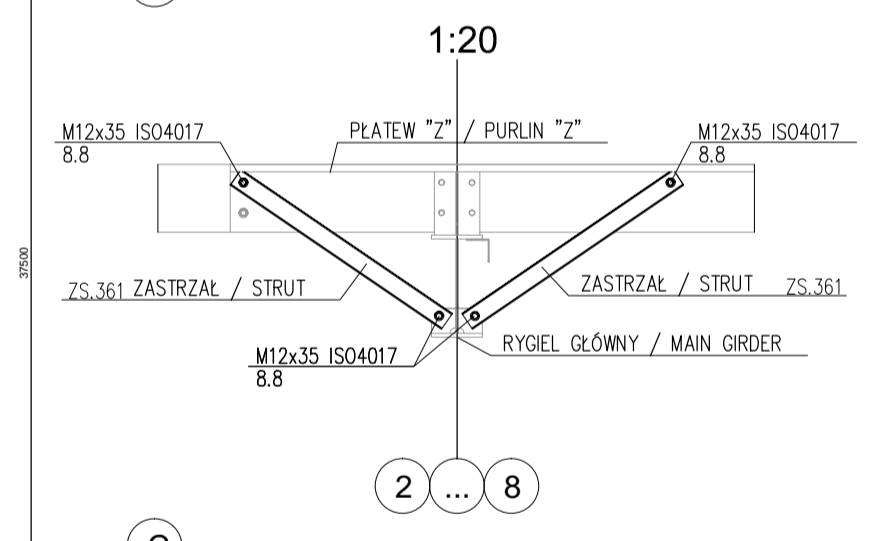
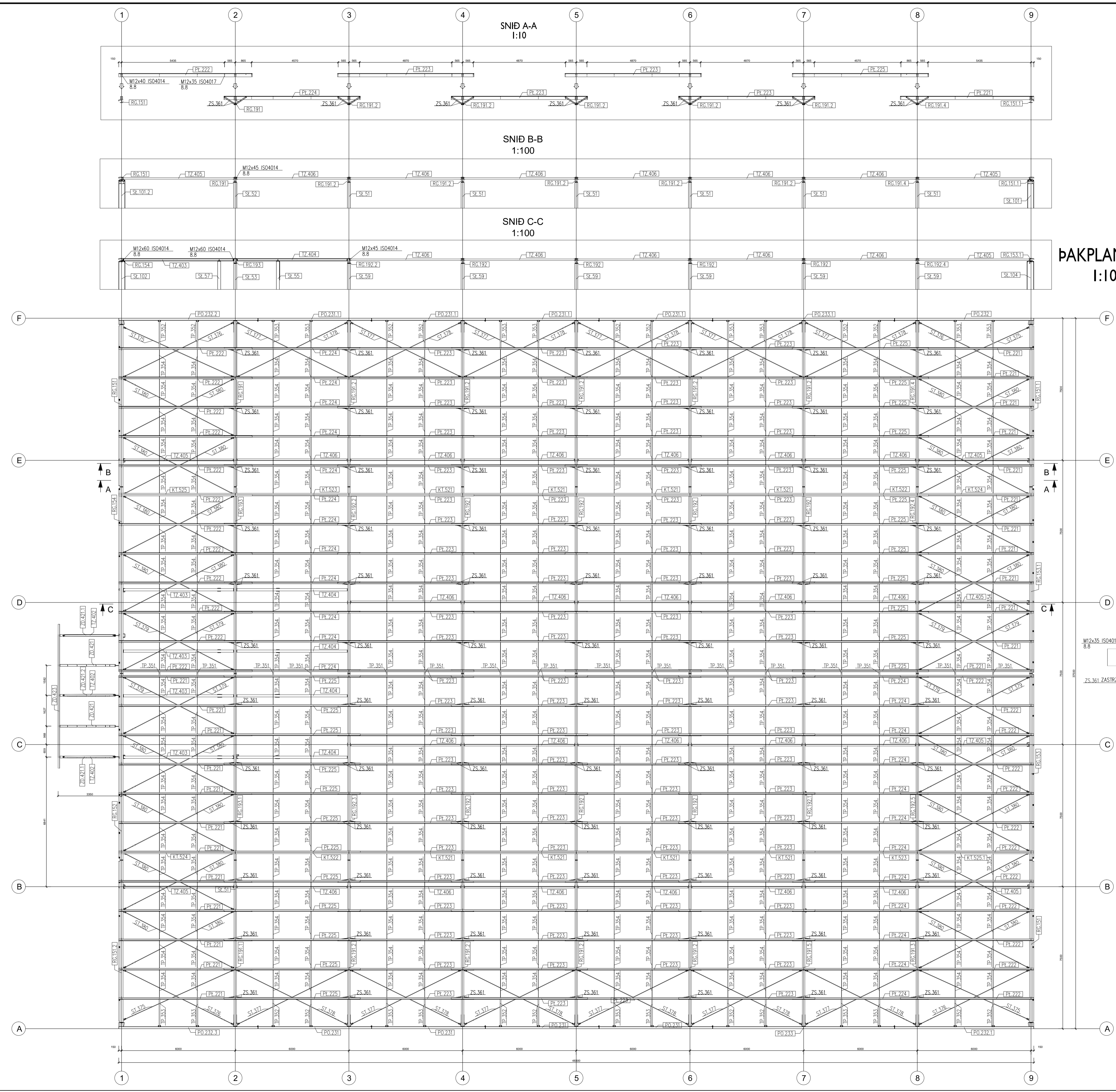

Verkfræðistofa Ívars Haukssonar ehf.
Suðurlandsbraut 46, 108 Reykjavík.
Sími: 695-4337
e-mail: ivar@vha.is
www.vha.is
Kennitala: 540212-2790

Hannað I.H.	Teknað I.H.	Sampbykkt Kennitala
		110383-5339
STÁLHELLA 14		
HAFNARFIRÐI		
BURÐARVIRKI		
ÞAKVIRKI		
SNÍÐ		
Mkv. 1/100	Tekn. nr. 2-2.1	Verk nr. 1255
Áritun samræmingarhönnuðar / hönnunarskjóra:		Útgáfa Dags. A JUN 23

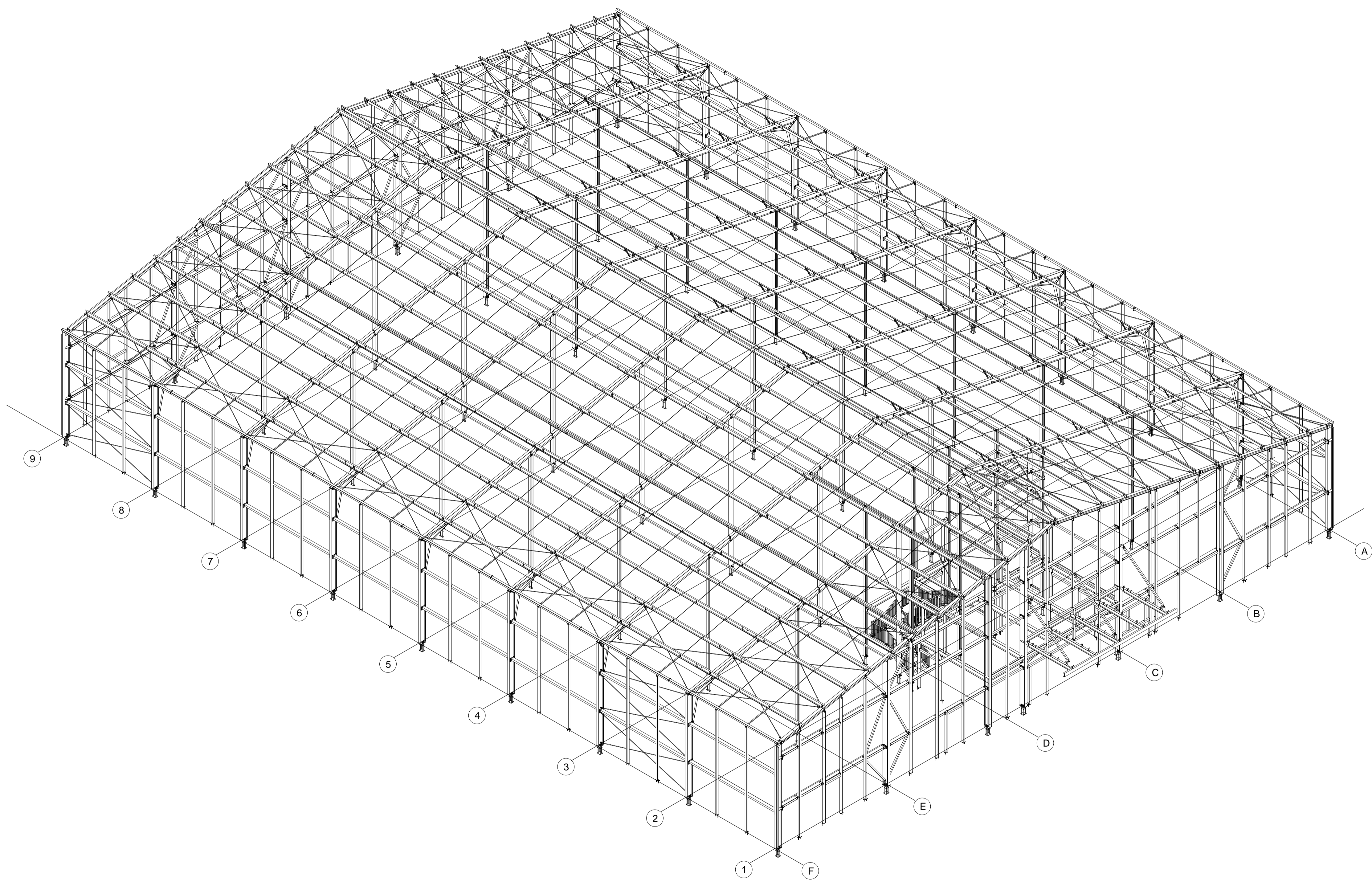

Verkfræðistofa Ívars Haukssonar ehf.
 Suðurlandsbraut 46, 108 Reykjav.
 Sími: 695-4337
 e-mail: ivar@vha.is
 www.vha.is
 Kennitala: 540212-2790

Hannað Í.H.	Teiknað Í.H.	Samþykkt Kennitala 110383-5339
----------------	-----------------	-----------------------------------

STÁLHELLA 14
 HAFNARFIRÐI
 BURÐARVIRKI
 YFIRLITSMYND 3D

Mkv. 1/100	Teikn. nr. 2-2.2	Verk nr. 1255
---------------	----------------------------	------------------

Áritun samræmingarhönnuðar / hönnunarstjóra:	Útgáfa A	Dags. JUN '23
--	-------------	------------------